

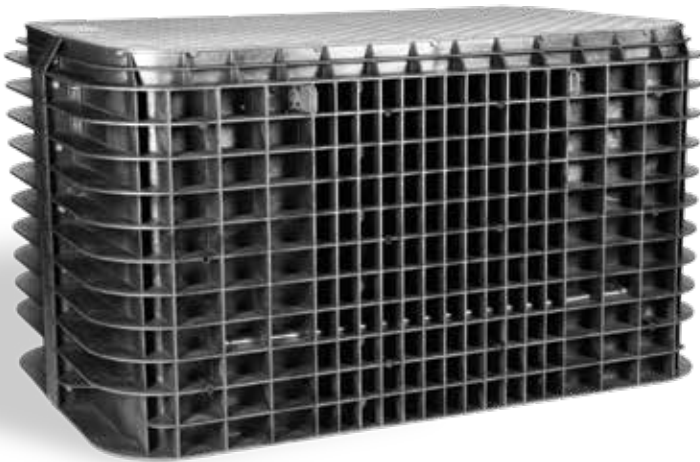

## TECHNICAL SPECIFICATIONS

### Grade Level Box BULK ⑧ Series



36"/914 mm depth

Now with  Covers

## FEATURES

- Upgradeable
- Lightweight/Strong (TIER 22)
- Patented Anti-Slip Technology
- Anti-Seize Bolt Technology
- Industry Leader in Anti-Trip Hazard Prevention
- Superior Fatigue Resistance (EST)<sup>™</sup>
- Vertical and Horizontal Rib Design
- Embedded Vertical Racking
- Reduced Installation Cost
- Highest Load Rating to Weight Ratio in the Industry

## TESTING CRITERIA

Covers meet or exceed:

- EST<sup>™</sup> 3 Million Cycles
- Telcordia GR-902-CORE
- Western Underground Committee Guide 3.6
- ANSI/SCTE 77 2013-TIER 22
- EN124 Class A15/B125

Bodies meet or exceed:

- Telcordia GR-902-CORE
- Western Underground Committee Guide 3.6
- ANSI/SCTE 77 2013-TIER 22
- EN124 Class A15/B125/C250
- ASTM-457
- AASHTO M-306 (H-20/25)
- AS3996-Class B/C



CHANNELL

channell.com

## PRODUCT SUMMARY

With over 90 years experience in global (OSP) infrastructure, Channell has developed the most advanced pit and chamber technology in the world! Channell's BULK and SHIELD patented designs with the complement of SUPER BULK for roadway applications offer global users, consumer, and craft installers safety benefits never before contemplated, but critical when considering new global health and safety standards.

BULK's lightweight design increases installation efficiencies while improving overall body weight carrying load capacities versus concrete, polymer concrete, and many other body materials. Reduction of BULK's body weight protects the safety of installers while shortening installation times. Additionally, with BULK bodies, cutting ducts in the field produces no harmful dust contaminants which could lead to installer respiratory issues.

All SHIELD covers meet or exceed 33,750 pound-force or 150 kilonewtons in strength. They never break and offer a lid weight reduction over concrete and polymer concrete of 50%, and over 70% when compared to cast iron. SHIELD's lighter weight design cover reduces craft injuries while improving health and safety specifications.

Consumers also benefit from SHIELD's patented anti-slip design and anti-trip features. SHIELD's cover tread design raises global industry standards by offering 20% greater slip resistance when compared to concrete, polymer concrete, steel or cast iron covers. SHIELD meets and exceeds Australia AS4586 skid specification, the highest global standard in the world!

Overall, BULK's strength in combination with Channell's SHIELD covers offers a universal solution to meet and exceed every company's needs. Safety always comes first, and that's why BULK and SHIELD are tested to the highest standards available in the global market and Channell is proud to have pioneered Endurance Stress Testing (EST™) which analyzes cover fatigue in the field. EST™ provides essential data on the life expectancy of a SHIELD lid in the field and confirms its potential life expectancy. Product design, product innovation, safety attributes, and new manufacturing technology is why global customers are specifying Channell's BULK and SHIELD products for their new OSP infrastructure requirements.



## STANDARD FEATURES



Anti-Slip Tread Design

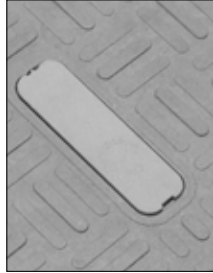

Anti-Trip Cover



Recessed Lifting Pin  
with Cover



Non-Seizing Bolt System  
Allows Field Replacement



Flush Mounted Sidewall Racks  
Increase Usable Space



Mounting Studs



Logo Puck  
(Custom Options Available)



4 Lifting Points



8 Multiple Conduit Points  
at Each End

## OPTIONAL FEATURES



L-Bolt Security System  
(SHIELD Cover Shown)



Marker Locator Device



Swing-Arm with Butterfly  
Mounting Plate



Cable Hook  
Bracket









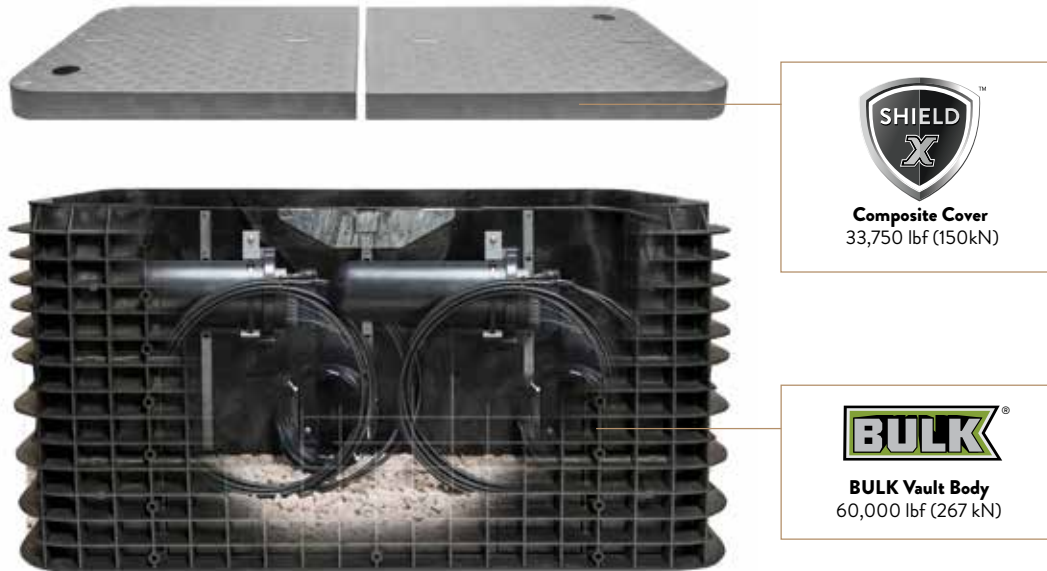





Step Bracket  
with Wedge

Design and specifications may vary.

THE NEW SOLUTION



SPECIFICATION	PROOF LOAD	PRODUCTS
<b>AMERICAS</b>	<b>STANDARDS</b>	
ANSI/SCTE 77 TIER 22	33,750 lbf (150 kN)	 
<b>EMEA</b>	<b>STANDARDS</b>	
Pedestrian/Light Duty	2,250 lbf (10 kN)	 
EN 124 Class B125	28,100 lbf (125 kN)	 
<b>APAC</b>	<b>STANDARDS</b>	
Pedestrian/Light Duty	3,370 lbf (15 kN)	 
AS3996-Class B	18,000 lbf (80 kN)	 
AS3996-Class C	33,750 lbf (150 kN)	 

### BODY DESIGN

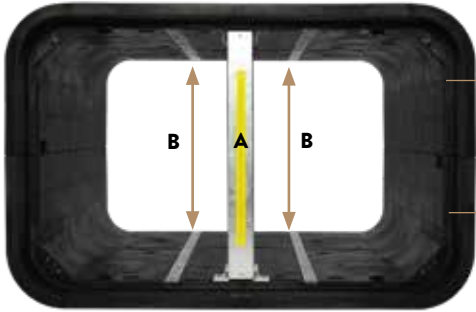

- A Crossbar Support
- B Standard flush mounted sidewall racks

Straight wall design improves lid load strength.

Flush mounted racks enhance sidewall and vertical strength of pit while increasing usable space.

Ribbed sidewall design secures body into backfill soil and eliminates sidewall deflection.

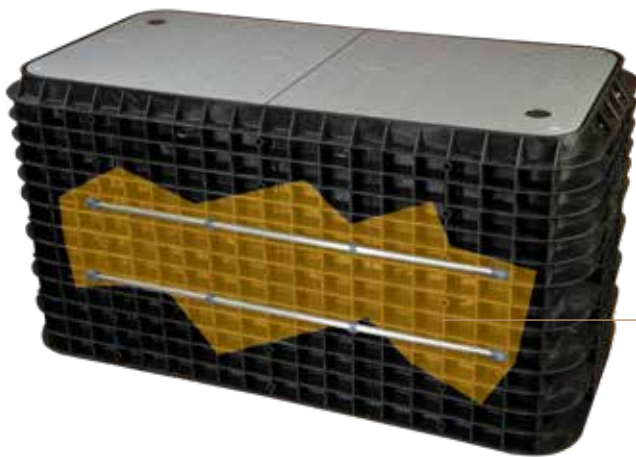
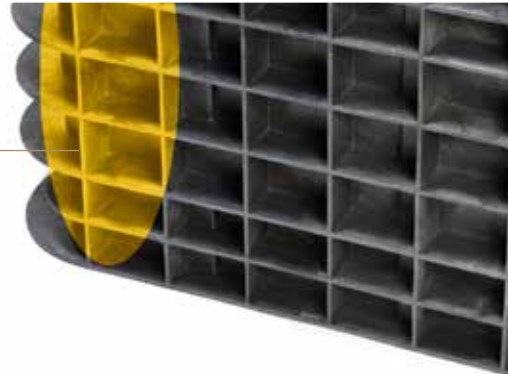

Stainless steel tube is constructed into sidewall of pit to prevent sidewall deflection on BULK bodies 24" (610 mm) and deeper.

HDPE bodies provide easy field alteration while eliminating water absorption and material degradation while maintaining structural integrity, and eliminating toxic fiberglass dust.



### BODY SPECIFICATIONS

<b>Cover Weight</b> (Split 1/2 Cover)	76 lbs	[34 kg]
<b>Pit Weight</b>	274 lbs	[124kg]
<b>Assembled Weight</b>	426 lbs	[193 kg]

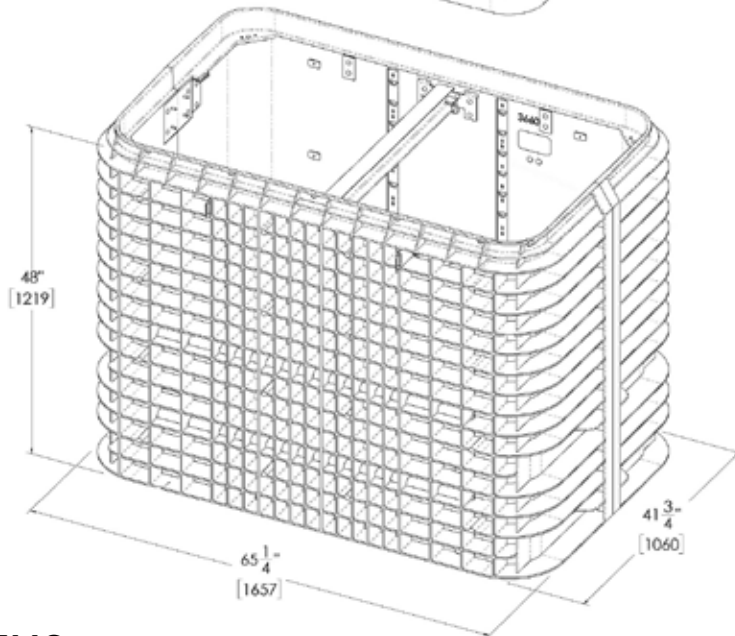
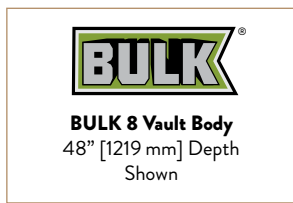
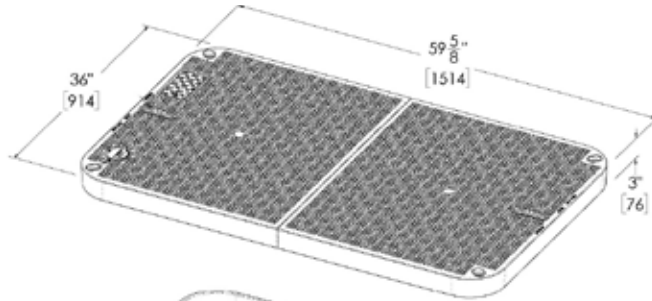

### ADDITIONAL BODY DEPTHS

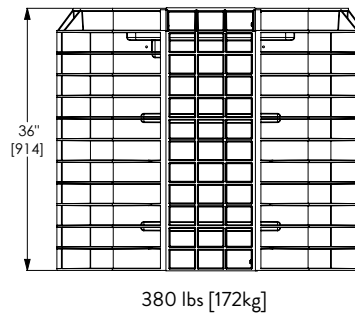
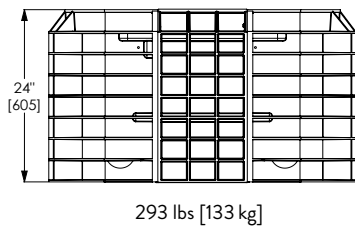

UNITED STATES  
800.423.1863

CANADA  
905.565.1700

EUROPE, MIDDLE EAST, AFRICA  
44.1322.312590

AUSTRALIA, ASIA, PACIFIC RIM  
61.2.8884.4111

[www.channell.com](http://www.channell.com)